









ST. TROPEZ

BY C.R. PLASTIC PRODUCTS INC



C35 St. Tropez Dining Side Chair

C.R. Plastic Products Inc.
1 – 533 Romeo Street South
Stratford Ontario N5A 4V3
Toll Free: 800-490-1283
Fax: 519-271-8544
www.crpproducts.com

<p>A. Seat Qty. 1</p> 	<p>B. Back Qty. 1</p> 
<p>C. Right Leg Qty. 1</p> 	<p>D. Left Leg Qty. 1</p> 
<p>E. Short Stringer Qty. 1</p> 	<p>F. Long Stringer Qty. 2</p> 

PARTS LIST:

- A - Seat**
- B - Back**
- C - Left Leg**
- D - Right Leg**
- E - Short Stringer**
- F - Long Stringer**

HARDWARE LIST:

- 13 – 1½” Screws
- 10 – 2½” Screws

Note:

- Read these instructions carefully before assembling.
- Tools required: # 2 Phillips or #2 Robertson bit and power drill.
- Find a clean, smooth area on which to work, such as a carpet, in order to avoid scratching the plastic surfaces.
- Two people might be required for assembly.
- **Caution!! Do not over tighten screws.**

Step 1: Attach Short Stringer (E) to Right Leg (C) using 1 - 1½” screw and 1 - 2½” screw. Detail X
Repeat for Left Leg (D).

Required	Qty
Right Leg(C)	1
Left Leg (D)	1
Short Stringer(E)	4
1½” Screws	2
2½” Screws	2

Figure 1

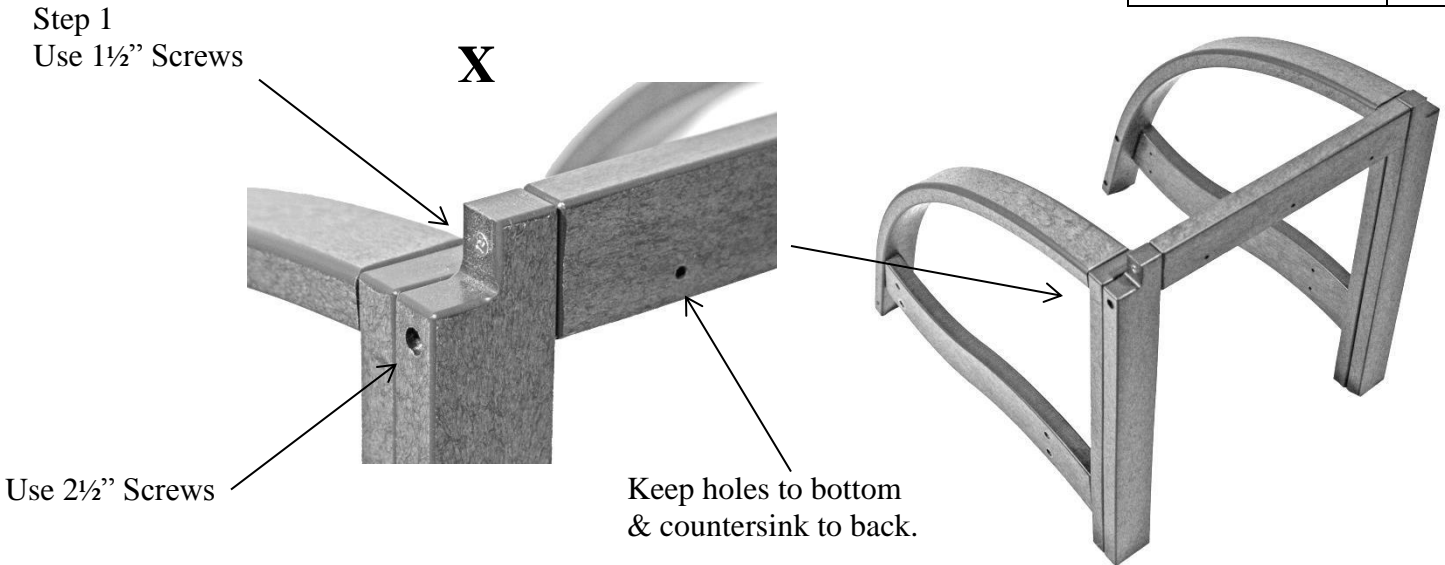

Step 2: Attach Leg assembly from step 1 to Seat (A). Use 3 - 1½” screws.

Required	Qty
Seat (A)	1
1½” Screws	3

Figure 2

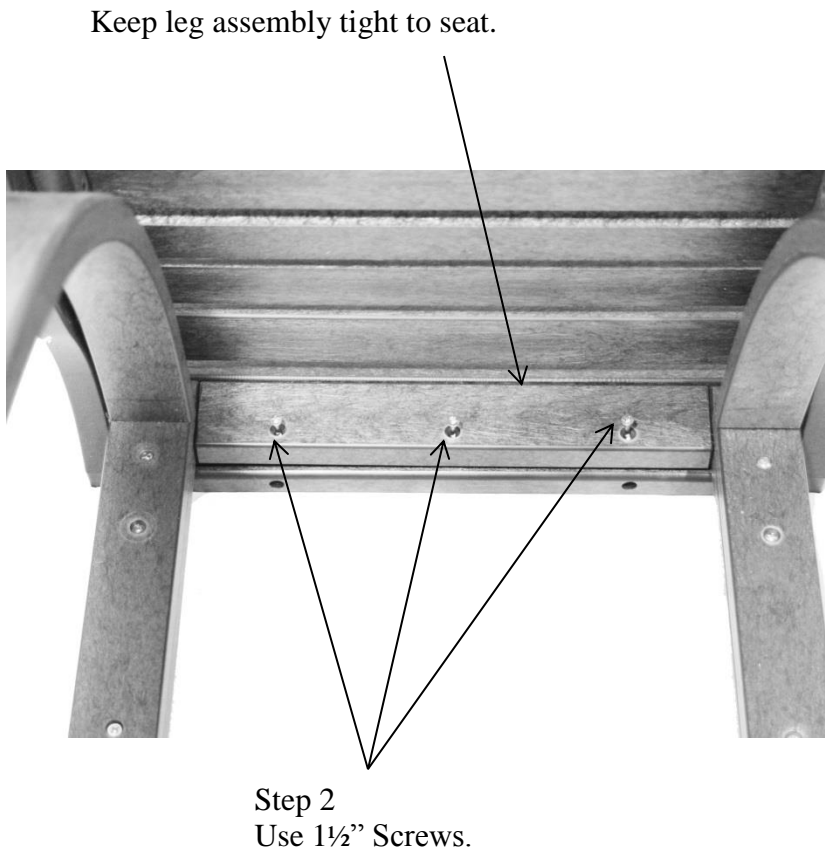

Step 3: Attach Back (B) to leg supports with 4 - 2½” screws (detail Y).

Step 4: Attach Back (B) to seat with 4 - 2½” screws.

Step 5: Attach back Long Stringer (F) with 4 - 1½” screws.

Step 6: Attach front Long Stringer (F) with 4 - 1½” screws..

Required	Qty
Back (B)	1
Long Stringer (F)	2
1½” Screws	8
2½” Screws	8

Figure 3

